

Hybrid Solar Inverter

PV5000-24

User Manual

Table Of Contents

1. Information on this Manual	04
1.1 Validity	04
1.2 Scope	04
1.3 Target Group	04
1.4 Label Description	04
1.5 Safety Instructions	05
2. Introduction	06
2.1 Features	07
2.2 Product Overview	07
3. Installation	08
3.1 Unpacking and Inspection	08
3.1.1 Open-box Inspection	08
3.1.2 Installation Tools	09
3.1.3 Packing List	09
3.2 Mounting Unit	10
3.3 External Protective Grounding Connection	12
3.4 AC Input / Output Connection	13
3.5 PV Connection	16
3.6 Battery Connection	18
3.6.1 Lead-acid Battery Connection	18
3.6.2 Lithium Battery Connection	20
3.7 Final Assembly	21
3.8 Smart Communication Stick Connection(Optional)	21
4. Operation	21
4.1 Power ON/OFF	21
4.2 Operation and Display Panel	22
4.2.1 LCD Display Icons	23
4.2.2 LCD Setting	24
4.3 Display Information	35
5. Fault Reference Code	39
6. Alarm Reference Code	42
7. Battery Equalization	45
8. Specifications	47
8.1 Line Specifications	47
8.2 Battery Specifications	49
8.3 Charger Specifications	49
8.4 Output Specifications	50
8.5 Switch Time Specifications	51
8.6 Efficiency Specifications	52
9. Trouble Shooting	52

1. Information on this Manual

1.1 Validity

This manual is valid for the following devices:

- 3600W inverter

1.2 Scope

This manual describes the assembly, installation, operation and troubleshooting of this unit. Please read this manual carefully before installations and operations.

1.3 Target Group





This document is intended for qualified persons and end users. Tasks that do not require any particular qualification can also be performed by end users. Qualified persons must have the following skills:

- Knowledge of how an inverter works and is operated
- Training in how to deal with the dangers and risks associated with installing and using electrical devices and installations
- Training in the installation and commissioning of electrical devices and installations
- Knowledge of the applicable standards and directives
- Knowledge of the compliance with this document and all safety information



1.4 Label Description

In order to ensure the user's personal safety when using this product, the inverter and manual provides relevant identification information and uses appropriate symbols to alert the user, who should carefully read the following list of symbols used in this manual.

Labels on Inverter

	CAUTION Do not disconnect under load!
	Danger: High Voltage! Danger: Electrical Hazard!
	Start maintaining the INVERTER at least 5 minutes after the INVERTER disconnected from all external power supplies.
	Read instructions carefully before performing any operation on the INVERTER.
	Grounding: The system must be firmly grounded for operator safety.

Labels in the documentation

 WARNING!	A high level of potential danger, which, if not avoided, could result in death or serious injury to personnel.
 CAUTION!	A moderate or low level of potential danger, which, if not avoided, could result in moderate or minor injuries to personnel. In some bad situation, it could result in death or serious injury to personnel.

1.5 Safety Instructions



WARNING!

**This chapter contains important safety and operating instructions.
Read and keep this manual for future reference.**

01. Please be clear which kind of battery system you want, lithium battery system or lead-acid battery system, if you choose the wrong system, energy storage system can't work normally.
02. Before using the unit, read all instructions and cautionary marking on the unit, the batteries and all appropriate sections of this manual. The company has the right not to quality assurance, if not according to the instructions of this manual for installation and cause equipment damage.
03. All the operation and connection please professional electrical or mechanical engineer.
04. All the electrical installation must comply with the local electrical safety standards.
05. When install PV modules in the daytime, installer should cover the PV modules by opaque materials, otherwise it will be dangerous as high terminal voltage of modules in the sunshine.
06. CAUTION - To reduce risk of injury, charge only deep-cycle lead-acid type rechargeable batteries and lithium batteries. Other types of batteries may burst, causing personal injury and damage.
07. Do not disassemble the unit. Take it to a qualified service center when service or repair is required. Incorrect re-assembly may result in a risk of electric shock or fire.
08. To reduce risk of electric shock, disconnect all wirings before attempting any maintenance or cleaning. Turning off the unit will not reduce this risk.
09. NEVER charge a frozen battery.
10. For optimum operation of this inverter, please follow required spec to select appropriate cable size. It's very important to correctly operate this inverter.

11. Be very cautious when working with metal tools on or around batteries. A potential risk exists to drop a tool to spark or short circuit batteries or other electrical parts and could cause an explosion.
12. Please strictly follow installation procedure when you want to disconnect AC or DC terminals. Please refer to INSTALLATION section of this manual for the details.
13. GROUNDING INSTRUCTIONS - This inverter should be connected to a permanent grounded wiring system. Be sure to comply with local requirements and regulation to install this inverter.
14. NEVER cause AC output and DC input short circuited. Do NOT connect to the mains when DC input short circuits.
15. Make sure the inverter is completely assembled, before the operation.

2.Introduction

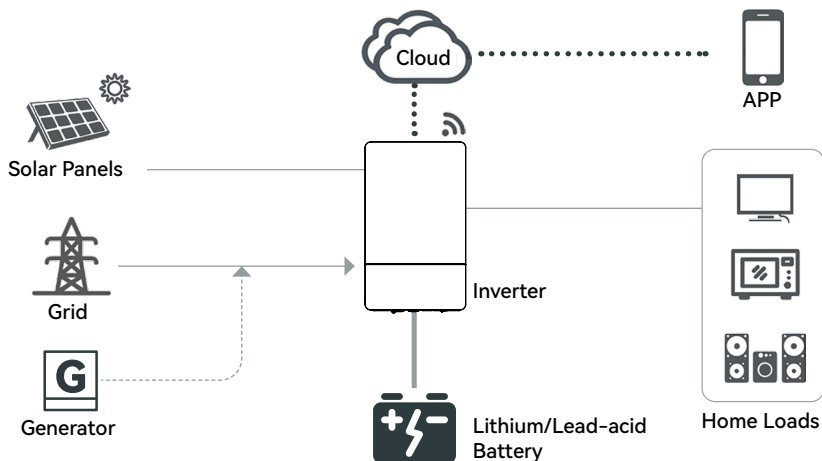

Hybrid Solar Energy Storage System

This is a multifunctional solar inverter, integrated with a MPPT solar charge controller, a high frequency pure sine wave inverter and a UPS function module in one machine, which is perfect for off grid backup power and self-consumption applications. This inverter can work with or without batteries.

The whole system also need other devices to achieve complete running such as PV modules, generator, or utility grid. Please consult with your system integrator for other possible system architectures depending on your requirements. The WiFi / GPRS module is a plug-and-play monitoring device to be installed on the inverter. With this device, users can monitor the status of the PV system from the mobile phone or from the website anytime anywhere.

2.1 Features

- Rated power 3,6KW, power factor 1
- MPPT ranges 40V~450V, 500Voc
- High frequency inverter with small size and light weight
- Pure sine wave AC output
- Solar and utility grid can power loads at the same time
- With CAN/RS485 for BMS communication
- With the ability to work without battery
- WIFI/ GPRS remote monitoring (optional)

2.2 Product Overview

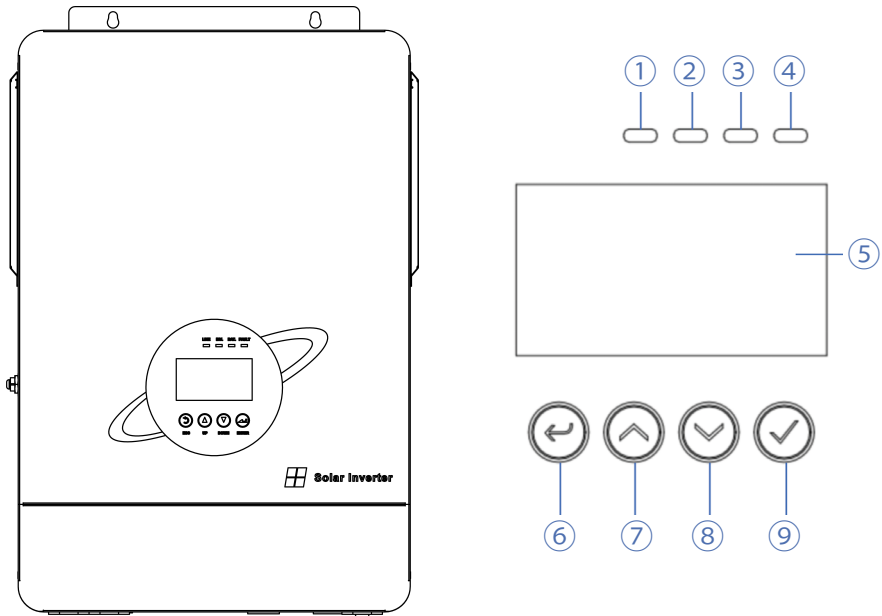

① AC Indicator

② Invert Indicator

③ Charging Indicator

④ Fault Indicator

⑤ LCD Display

⑥ ESC Button

⑦ Up Button

⑧ Down Button

⑨ Enter Button

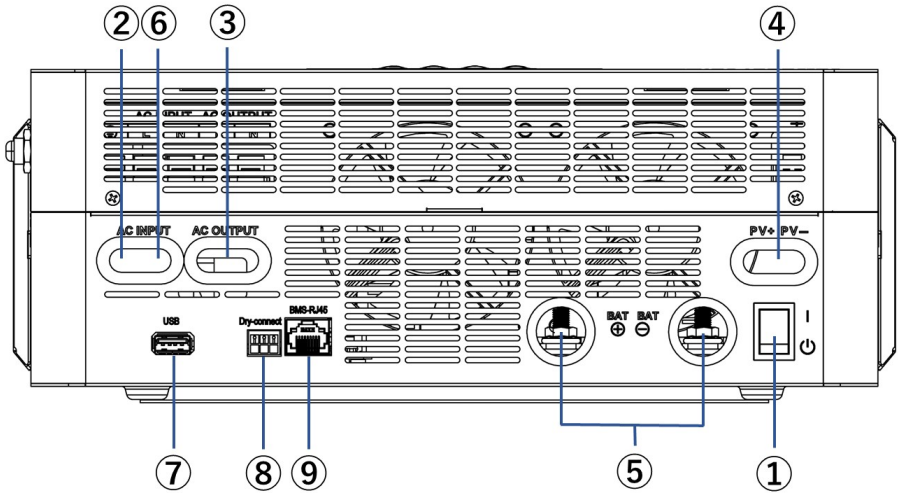

- ① Power On/Off Switch
- ② AC Input
- ③ AC Output
- ④ PV Input
- ⑤ Battery Input
- ⑥ Grounding
- ⑦ WiFi/GPRS Communication Port
- ⑧ Dry Contact
- ⑨ BMS Communication Port (Support CAN/RS485 Protocol)

3. Installation

3.1 Unpacking and Inspection

3.1.1 Open-box Inspection

Products have been strictly tested before leaving the factory. Please sign for them after inspection. If the product is damaged, please contact the local distributor. Please open the box to check whether the outer packaging is intact or damaged, whether the internal equipment is damaged.

3.1.2 Installation Tools

Installation Tools	Multi-meter 	Protective gloves 	Insulated anti-smashing shoes 
	Safety glasses 	ESD wrist strap 	Hammer drill 
	Electric screwdriver 	Cross screwdriver 	Rubber mallet 
		Wire cutter / stripper 	Terminal crimping tool 

3.1.3 Packing List

No.	Item	Quantity	Description	Remarks
1	Inverter	1		
2	User manual	1	English	
3				
4				
5				

3.2 Mounting Unit

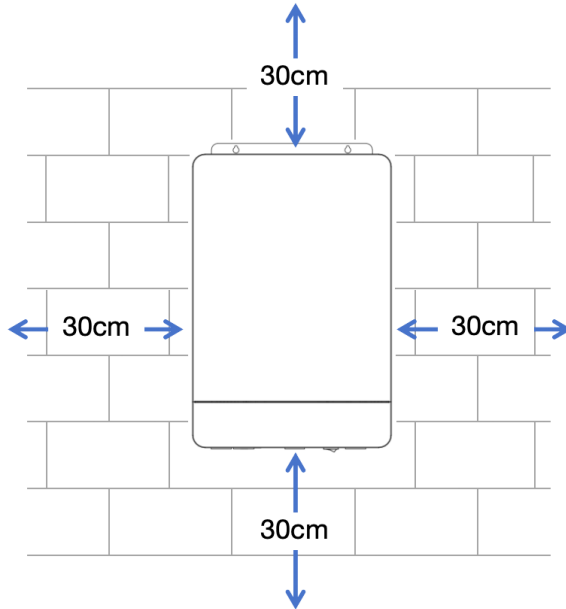

Consider the following points before selecting where to install:

- Do not mount the inverter on flammable construction materials.
- Mount on a solid surface.
- Install this inverter at eye level in order to allow the LCD display to be read at all times.
- The ambient temperature should be between -15°C and 60°C to ensure optimal operation.
- The recommended installation position is to be adhered to the wall vertically.
- Be sure to keep other objects and surfaces as shown in the diagram above to guarantee sufficient heat dissipation and to have enough space for removing wires.



WARNING!

Inverter is suitable for mounting on concrete or other non-combustible surface only.

Follow the installation steps:

1. Use $\phi 8$ drilling bit drill holes on the mounting surface. The distance between 2 holes is 200mm. Then insert the expansion screw(M6). M6 expansion screw is suggested.

2. Pick up the inverter vertically and align the screw at the top of the inverter with the screw already installed on the wall. Hang the inverter on the mounting surface by the screws. Before connecting all wiring, please take off bottom cover by removing JAscrews as shown below:

3.3 External Protective Grounding Connection



DANGER

Ensure a reliable connection of the grounding wire to prevent electrical shock hazards.



WARNING

- The external grounding protection point provides a reliable grounding. Do not use
- inappropriate grounding conductors as it may result in product damage or personal injury.
- If unsure about the grounding connection, please consult a professional for proper guidance.

The external grounding cable is to be prepared by customer. The grounding cable must be yellow-green color. OT terminals with insulating jacket is in the packing.

1. Remove insulation sleeve a proper length from the head of cables.



2. Use OT terminal crimping tool make cable and terminal crimped tightly.



3. Connect the ground cable with M4 screw.

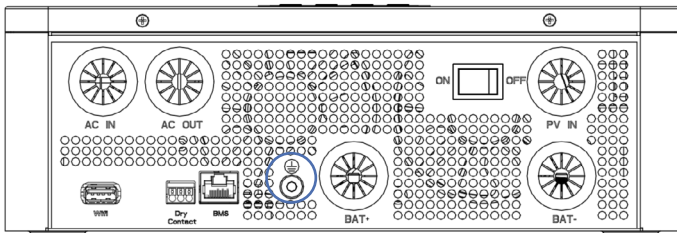

3.4 AC Input / Output Connection



CAUTION!

Before connecting to AC input power source, please install a separate AC breaker between inverter and AC input power source. This will ensure the inverter can be securely disconnected during maintenance and fully protected from over current of AC input. The recommended spec of AC breaker is 25A for 3,6KW inverter.



CAUTION!

There are two terminal blocks with “AC IN”, “AC OUT” markings. Please do NOT mis-connect input and output connectors.



CAUTION!

Be sure to connect AC cables with correct polarity. If L and N wires are connected reversely, it may cause utility short-circuited when these inverters are worked in parallel operation



WARNING!

All wiring must be performed by a qualified personnel.



WARNING!

It's very important for system safety and efficient operation to use appropriate cable for AC input connection. To reduce risk of injury, please use the proper recommended cable size as below.

Suggestion for AC input wires

Model	Gauge	Cable (mm ²)
3.6KW Inverter	14 AWG	2.075



WARNING!

It's very important for system safety and efficient operation to use appropriate cable for AC dual output connection. To reduce risk of injury, please use the proper recommended cable size as below.

Suggestion for AC output wires

Model	Gauge	Cable (mm ²)
3.6KW Inverter	14 AWG	2.075



WARNING!

Make sure AC power is disconnected before attempting to connect AC power to the unit.

All operations during the electrical connection process, as well as the specifications of cables and components used, must comply with local laws and regulations. The cable color mentioned below is for typical reference.

Please follow below steps to implement AC input / output connection:

1. Before making AC connection, be sure to open AC circuit breaker first.
2. Remove insulation sleeve 12mm from the head of cables, shorten the conductor part to 10 mm. Insert the cable into the tubular terminal. Then use terminal crimping tool make the terminal and cable connected tightly.

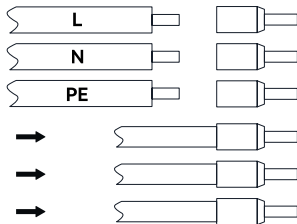

3. Insert AC input/output cables according to polarities indicated on terminal block and tighten the terminal screws. Be sure to connect PE protective cable first.

PE → Protecting Earth (yellow-green)

L → LINE (brown or black)

N → Neutral (blue)

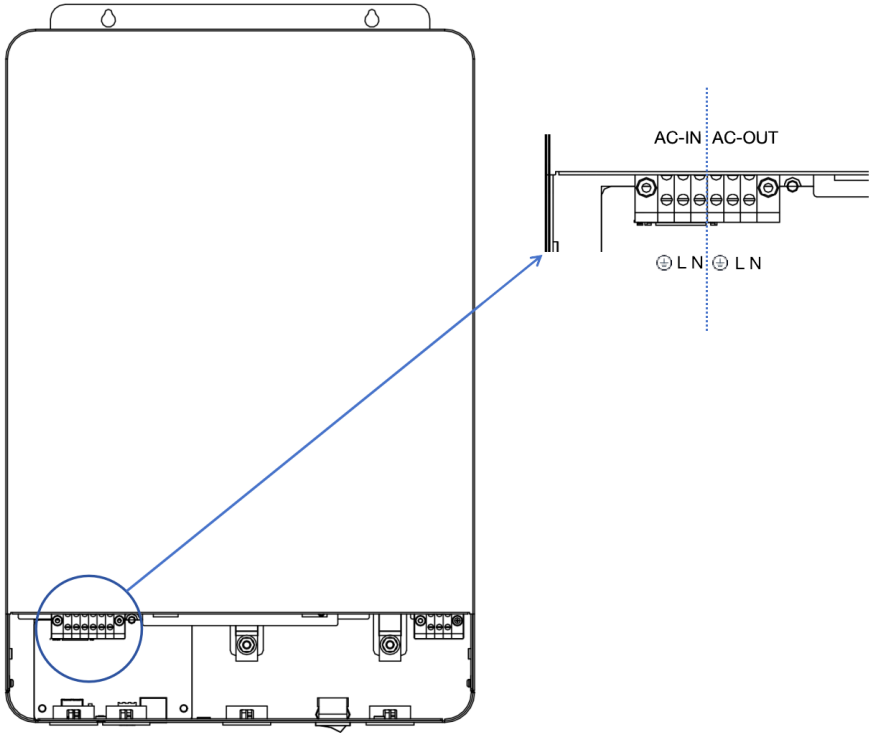

4. Make sure the cables are securely connected.



CAUTION!

Appliances such as air conditioner are required at least 2~3 minutes to restart because it's required to have enough time to balance refrigerant gas inside of circuits. If a power shortage occurs and recovers in a short time, it will cause damage to your connected appliances. To prevent this kind of damage, please check with manufacturer of air conditioner that if it's equipped with time-delay function before installation. Otherwise, this off grid solar inverter will trig overload fault and cut off output to protect your appliance but sometimes it still causes internal damage to the air condition.

3.5 PV Connection



CAUTION!

Before connecting to PV modules, please install a separate DC circuit breaker between inverter and PV modules.

The recommended spec of DC breaker is 25A with a maximum operating voltage greater than 500VDC for 3.6KW inverter.



WARNING!

Do not ground the positive or negative terminals of the PV modules, as this can severely damage the inverter.



WARNING!

Exposure to sunlight can generate lethal high voltages in photovoltaic strings, so strictly adhere to the safety precautions listed in the photovoltaic string and related documents.



WARNING!

Make sure to connect the PV terminals to the corresponding ports on the inverter, as reversing the polarity can damage the inverter.



WARNING!

All wiring must be performed by a qualified personnel.



WARNING!

It's very important for system safety and efficient operation to use appropriate cable for PV module connection. To reduce risk of injury, please use the proper recommended cable size as below. The cable color mentioned below is for typical reference.

Model	Gauge	Cable (mm ²)
3.6KW Inverter	14 AWG	2.075

PV Module Selection:

When selecting proper PV modules, please be sure to consider below parameters:

1. Open circuit Voltage (Voc) of PV modules not exceeds max. PV array open circuit voltage of inverter.

2. Open circuit Voltage (Voc) of PV modules should be higher than start-up voltage.

INVERTER MODEL	3.6KW Inverter
Max. PV Array Open Circuit Voltage	500Vdc
Start-up Voltage	60Vdc
PV Array MPPT Voltage Range	40Vdc~450Vdc



WARNING!

Please do not connect any DC switches or AC/DC circuit breakers before completing the electrical connections.

Please follow below steps to implement PV module connection:

1. Before making PV connection, be sure to open DC circuit breaker first.
2. Remove insulation sleeve 12mm from the head of cables, shorten the conductor part to 10 mm. Insert the cable into the tubular terminal. Then use terminal crimping tool make the terminal and cable connected tightly

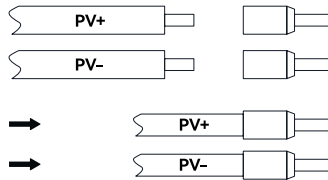

3. Use multi-meter check to ensure the polarities are correct.
4. Insert PV cables according to polarities indicated on terminal block and tighten the terminal screws.

- + → PV+ (red)
- → PV- (black)

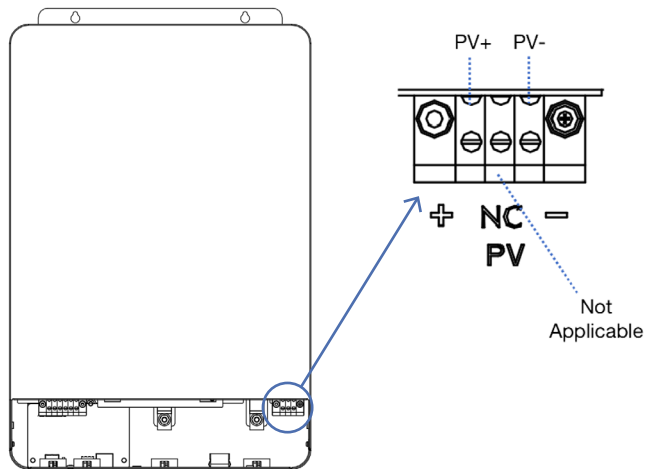

5. Make sure the cables are securely connected.

3.6 Battery Connection

3.6.1 Lead-acid Battery Connection

User can choose proper capacity lead acid battery with a nominal voltage at 24V. Also, you need to choose battery type as 'AGM or FLD(flooded)'



CAUTION!

For safety operation and regulation compliance, it's requested to install a separate DC over-current protector or disconnect device between battery and inverter. It may not be requested to have a disconnect device in some applications, however, it's still requested to have over-current protection installed. The recommended size of protector or disconnect is 175A.



WARNING!

All wiring must be performed by a qualified person.



WARNING!

It's very important for system safety and efficient operation to use appropriate cable for battery connection. To reduce risk of injury, please use the proper recommended cable and terminal size as below. The cable color mentioned below is for typical reference.



WARNING!

Make sure AC power is disconnected before attempting to connect AC power to the unit.
All operations during the electrical connection process, as well as the specifications of cables and components used, must comply with local laws and regulations. The cable color mentioned below is for typical reference.

Recommended battery cable and terminal size:

Model	Gauge	Cable (mm ²)
3.6KW Inverter	2 AWG	25

Note: For lead acid battery, the recommended charge current is 0.3C (C>battery capacity)

Please follow below steps to implement battery connection:

1. Unscrew the pre-fixed screws on battery poles. Prepare 2 DT terminals(It should fit for AWG2 cables).
2. Remove insulation sleeve 12mm from the head of cables, shorten the conductor part to 10 mm. Insert the cable into the DT terminal. Then use terminal crimping tool make the terminal and cable connected tightly.

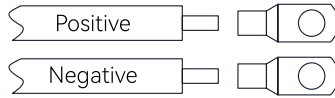

3. Pass the battery cable through the battery installation hole on bottom shell, and tighten the terminal screws. Make sure polarity at both the battery and the inverter/charge is correctly connected and DT terminals are tightly screwed to the battery terminals.

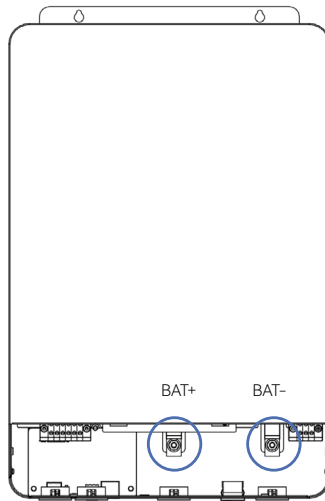

4. Connect all battery packs as units requires. It's suggested to connect at least 200Ah capacity battery.



WARNING! Shock Hazard

Installation must be performed with care due to high battery voltage in series.



CAUTION!

Do not place anything between the flat part of the inverter terminal and the DT terminal. Otherwise, overheating may occur.



CAUTION!

Do not apply anti-oxidant substance on the terminals before terminals are connected tightly.



CAUTION!

Before making the final DC connection or closing DC breaker/disconnector, be sure positive (+) must be connected to positive (+) and negative (-) must be connected to negative (-).

3.6.2 Lithium Battery Connection

If choosing lithium battery for inverter, Please check the compatibility of the protocol first. There're two connectors on the lithium battery, RJ45 port of BMS and power cable.

Please follow below steps to implement lithium battery connection:

1. Follow section 3.5.1 to implement the power cable connection.
2. Connect RJ45 terminal of battery communication cable to BMS communication port of inverter. The communication protocol should be RS485 or CAN.

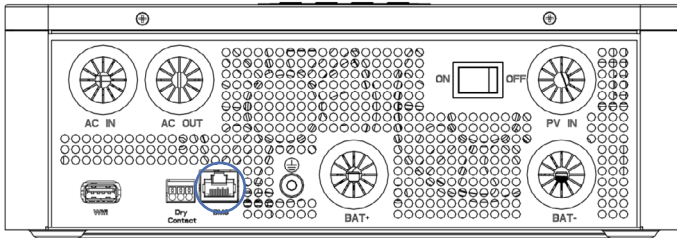

3. Insert the other end of RJ45 (battery communication cable) to battery communication port of lithium battery.

Note: If choosing lithium battery, make sure to connect the BMS communication cable between the battery and the inverter. You need to choose battery type as “lithium battery” during inverter setting.

Lithium battery communication and setting:

In order to communicate with battery BMS, you should set the battery type to “Lib” in Section 4.2.2 Program 17.

Make sure the lithium battery BMS port connects to the inverter is Pin to Pin, the inverter BMS port pin assignment shown as below:

Pin number	BMS port
1	RS485B
2	RS485A
3	-
4	CANH
5	CANL
6	-
7	-
8	-

3.7 Final Assembly

After connecting all wiring, please put bottom cover back by screwing four screws mentioned in Section 3.2.

3.8 Smart Communication Stick Connection(Optional)

The smart communication stick is used to connect to the cloud platform. Please insert the stick into COM port directly.

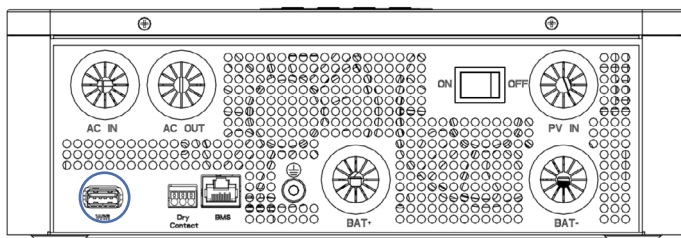

4. Operation

4.1 Power ON/OFF

Once the unit has been properly installed and the batteries are connected well, simply press ON/OFF switch (located on the button of the case) to turn on the unit.

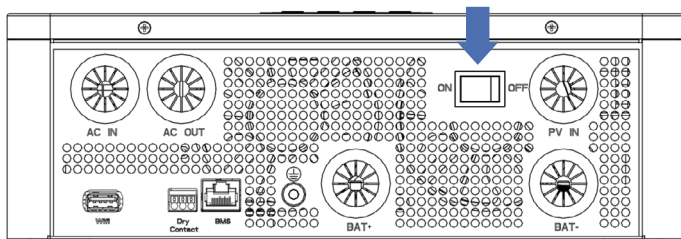

4.2 Operation and Display Panel

The operation and display panel, shown in below chart, is on the front panel of the inverter. It includes four indicators, four function keys and a LCD display, indicating the operating status and input/output power information.

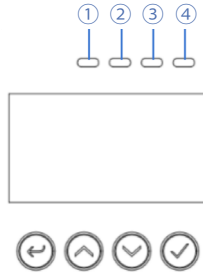

LED Indicator		Messages	
① AC	Status indicator (Green)	Solid On	The mains power is normal and enters the mains power operation.
		Flashing	The mains power is normal, but it has not entered mains power operation.
		Off	The mains power is abnormal.
② Inverter	Invert indicator (Yellow)	Solid On	Output is powered by battery or PV in battery mode.
		Off	Other states.
③ Charging	Charging indicator (Yellow)	Solid On	The battery is in float charging.
		Flashing	The battery is in constant voltage charging.
		Off	Other states.
④ Fault	Fault indicator (Red)	Solid On	Fault occurs in the inverter.
		Flashing	Warning condition occurs in the inverter.
		Off	The inverter is working properly.



ESC



UP



DOWN



ENTER

Function Buttons





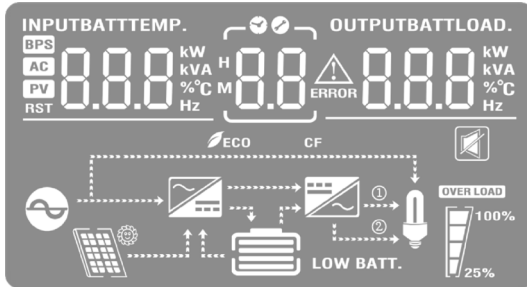







Button	Description
ESC	To exit setting mode
UP	To go to previous selection
DOWN	To go to next selection
ENTER	To confirm the selection in setting mode or enter setting mode

4.2.1 LCD Display Icons



Icon	Description
AC Input Information	
	AC input icon.
	Indicate AC input power, AC input voltage, AC input frequency, AC input current.
PV Input Information	
	PV input icon.
	Indicate PV power, PV voltage, PV current, etc.
Output Information	
	Inverter icon.
	Indicate output voltage, output current, output frequency, inverter temperature.
Load Information	
	Load icon.
	Indicate power of load, power percentage of load.
	Indicate overload happened.
Battery Information	
	Indicate battery level by 0-24%, 25-49%, 50-74% and 75-100% in battery mode and charging status in line mode.
	Indicate battery voltage, battery percentage, battery current.
Other Information	
	Indicate alarm code or fault code.
	Indicate a fault is happening.
	Indicate the alarm is disabled.
	Indicate power saving mode.

For Lead-acid battery, detailed description of battery icon as following:







In battery mode, battery icon will present Battery Capacity		
Load Percentage	Battery Cells Voltage	Display
Load >50%	< 11.146V	
	11.146V ~ 11.685V	
	11.685V ~ 12.224V	
	> 12.224V	
50%> Load > 20%	< 11.795V	
	11.795V ~ 12.334V	
	12.334V ~ 12.873V	
	> 12.873V	
Load < 20%	< 12.12V	
	12.12V ~ 12.659V	
	12.659V ~ 13.198V	
	> 13.198V	

4.2.2 LCD Setting

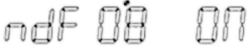
After pressing and holding ENTER button for 2 seconds, the unit will enter setting mode. Press “UP” or “DOWN” button to select setting programs. Then press “ENTER” button to confirm the selection or ESC button to exit.

Program	Description	Setting Option
01	Output voltage	OPV 01 230
		230V (default) Adjustable/settable value: 208V, 220V, 230V, 240V
02	Output frequency	OPF 02 50
		50Hz(default) Adjustable/settable frequency: 50Hz, 60Hz
03	Output source priority	Solar first OPP 03 PV
		Solar energy provides power to the loads as first priority. If solar energy is sufficient, battery will be charged with solar energy. If solar energy is not sufficient to power all connected loads, Grid will supply power to the loads at the same time. The extra power will charge the battery. If solar energy and grid are not sufficient, battery will supply power to the loads at same time. If solar, grid and battery power is not sufficient to power loads, inverter will go to standby and charge battery.
		Grid first (default) OPP 03 G+D
		Grid provides power to the loads as first priority. Solar power will charge the battery. If solar is not sufficient to charge battery, grid will charge the battery at the same time. If grid is not sufficient to power all connected loads, solar energy will supply power to the loads at the same time. If solar energy and grid are not sufficient, battery will supply power to the loads at same time. If solar, grid and battery power is not sufficient to power loads, inverter will go to standby and charge battery.

03	Output source priority	PBG priority	OPP 03 PBG
		<p>Solar energy provides power to the loads as first priority. If solar energy is sufficient, battery will be charged with solar energy.</p> <p>If solar energy is not sufficient to power all connected loads, battery will supply power to the loads at the same time.</p> <p>If solar energy and battery are not sufficient, grid will supply power to the loads at same time.</p> <p>If solar, grid and battery power is not sufficient to power loads, inverter will go to standby and charge battery.</p>	
04	Output mode	APP: Appliance (default)	oOd 04 APP
		Applied to household appliances	
		UPS	oOd 04 UPS
		Applied to computer and other devices. Typical switching time is 10ms.	
		GEN	oOd 04 GEN
Applied to connect generator by using grid input port			
05	Charger source priority	PNG: PV and Grid (default)	CHP 05 PNG
		OPV: Only PV	CHP 05 OPV
		GRD: Grid first	CHP 05 GRD
		PV: PV first	CHP 05 PV
		<p>There are four options for charging priority. The default is PNG (PV and Grid). PV and Grid are charged at the same time;. The second is OPV (Only PV). Only PV charge. The third is GRD (Grid). Grid charging takes priority. The fourth is PV. PV gives priority to charging.</p>	
06	Grid charging current		ACC 06 40
		<p>40A(default) Setting range is [2, 100A]</p>	

07	Maximum charging current		
		Set total charging current for solar and grid chargers. The default is 60A. Available options: 2/10/20/30/40/50/60/70/80/90/100A	
08	Menu Default		
		During setting: Set to ON. If the current page is not on the first page and no operation with 1 minute, the system will return to display the first page. Set to OFF. If the current page is not on the first page and no operation with 1 minute, the system will stay on the current page.	
09	Auto restart when overload occurs	The default is ON.	
10	Auto restart when over temperature occurs	The default is ON.	
11	Main input cut warning		
		Enable/Disable Mains or PV loss alarm. The default setting is ON. If the main input detected lost, the buzzer will sound for 3 seconds. when set to OFF, after the main input is lost, the buzzer will not sound.	
12	Energy-saving mode		
		The default setting is OFF. When set to ON, in battery mode, if the load is lower than 25W, the system will stop output for a period then resume. If the load is still lower than 25W, the system will do the loop stop then resume. If the load is higher than 35W, the system will resume continuous normal output.	
13	Overload transfer to bypass		
		The default setting is OFF. When set to ON, in the case of PBG priority output, if there is an overload, the system will immediately transfer to bypass mode (utility power output, also known as bypass mode).	

14	Silent mode setting	nbt 14 OFF	
		<p>Enable/disable buzzer sound. The default setting is OFF. When set to ON, in any situation such as alarms or faults, the buzzer will not sound. This setting can be applied to all modes .</p>	
15	Battery return to mains voltage point	bte 15 230	
		<p>When the battery is set to the CUS (Customer Setting Type) mode. The adjustable range is [22, 26V]. .</p>	
		<p>When the battery is set to the AGM (Lead Acid Battery Type) or FLD (Flooded Battery Type) mode. The default setting is 23V, and it can be adjusted within a range of [22, 26V].</p>	
		<p>When the battery is set to the LIB (Lithium Battery Type) mode. The default is 23.8V, and it can be adjusted within a range of [20, 25V].</p>	
16	Switching back to battery mode voltage points	bte 16 270	
		<p>When the battery is set to CUS (Customer Set Type) mode, The default setting is 26V, The voltage range is [24, 29V].</p>	
		<p>When the battery is set to AGM (Absorbent Glass Mat) or FLD (Flooded) mode,The default is 26V. It can be adjusted within a range of [24, 29V].</p>	
		<p>When the battery is set to LIB (Lithium Battery) mode, The default setting is 27V. It can be adjusted within a range of [23, 28.5V].</p>	
17	Battery type	AGM (default)	bat 17 AGM
		Flooded	bat 17 FLD
		Lithium	bat 17 LIB
		User-Defined	bat 17 CUS

18	Battery low voltage point	BAL 18 220
		It is not possible to set the battery definition mode to AGM or FLD mode. The initial default setting is 22V. When the battery type is set to CUS, the adjustable range for the battery voltage is [21, 27V].
		Battery low voltage alarm setting. When the battery type is set to LIB, the default setting is 23.8V. The adjustable range for the voltage is [20.6, 25V].
19	Battery shutdown voltage point	BAU 19 210
		The battery low voltage shutdown point setting function cannot be adjusted when the battery is defined as AGM or FLD mode. The default setting is 21V. When the battery type is set to CUS, the default setting is 21V. The adjustable range for the voltage is [20, 24V].
		When the battery type is set to LIB, the battery shutdown point can be modified. The default setting is 23V, and the adjustable range is [20, 24V].
20	Constant voltage mode voltage point setting	BCV 20 282
		When the battery is defined in AGM or FLD mode, the voltage set point cannot be configured. The default setting for AGM mode is 28.2V, for FLD mode is 29V. When the battery type is CUS, It can be set within the range of [24, 29V] for the constant voltage charging set point. It is important to note that the constant voltage set point voltage needs to be higher than the float charge set point voltage.
		When the battery type is set to LIB, the default constant voltage charging set point is 28.2V, and it can be adjusted within the range of [25, 29V]. It is important to ensure that the constant voltage set point voltage is higher than the float charge set point voltage.
21	Floating charge mode voltage point setting	BFL 21 270
		When the battery is defined in AGM or FLD mode, the voltage set point cannot be configured. The default setting for AGM/FLD mode is 27V. When the battery type is CUS, It can be set within the range of [26.6, 27.8V] for the floating charging voltage set point. If the battery type is LIB, the default setting for the floating charging point is 27.6V. The setting range is between 24V and 28V. It is important to note that the constant voltage point voltage should always be set higher than the floating charge point voltage.

22	Grid low voltage point setting	LLV 22 154.
		<p>If output mode is APP/GEN, Grid low voltage point can be set within a range of 90V to 154V. The default setting is 154V.</p> <p>If output mode is UPS, Grid low voltage point can be set within a range of 170V to 200V. The default setting is 185V.</p>
23	Grid high voltage point setting	LHV 23 264.
		<p>If output mode is APP/GEN, Grid high voltage point can be set within a range of 264V to 280V. The default setting is 264V.</p> <p>If output mode is UPS, Grid high voltage point is set as 264V.</p>
24	Low power discharge time setting	Lwd 24 8
		<p>When in battery mode and operating under a low load, unrestricted discharge for an extended period can deplete the battery, affecting its lifespan. When the inverter reaches the set low power discharge time, the low voltage shutdown point will be raised to 22V. The default low power discharge time is 8 (8 hours), adjustable range [1, 8].</p> <p>In inverter mode, the low power discharge time setting, the default is 8(8 hours), the setting range is [1, 8].</p> <p>In battery mode, after the continuous discharge time exceeds 8 hours and the battery shutdown point has not been reached, the battery voltage shutdown point will be modified to 22V, and the system will alarm for 1 minute when the battery continues to discharge to 22V. Then shut down again. When the battery voltage exceeds 26.4V exceeds 30s, the battery discharge time will be reset..</p>

25	Inverter soft start setting	S+E 25 OFF
		<p>Default setting is OFF.</p> <p>If it set to ON, the inverter output gradually increases from 0 to the target voltage value. If OFF, the inverter output directly increases from 0 to the target voltage value.</p> <p>Setting Condition: It can be set in single-machine operation mode.</p>
26	Reset factory setting	S+d 26 OFF
		<p>Restore all settings to factory default values.</p> <p>Before the setting, this interface is displayed as OFF. When set to ON, the system will restore to default settings. After the setting is completed, this interface will display OFF again.</p> <p>The setting can be applied immediately in mains and standby modes, but cannot be set in battery mode.</p>
27	Parallel operation mode	PAn 27 S!G!
		Not Applicable for this model.
28	Battery Disconnection Alarm	SbA 28 OFF
		<p>Enable/Disable battery disconnection alarm.</p> <p>Default setting is OFF. When set to OFF, there will be no battery disconnection, low battery voltage, or battery under voltage alarms when the battery is disconnected.</p>
29	Battery Equalization Mode	E9n 29 OFF
		<p>Enable/Disable Battery equalization.</p> <p>Default setting is OFF. If it is set to ON, the controller will start to enter the equalization phase when the set equalization interval (battery equalization period) is reached during the float charging stage, or the equalization is activated immediately.</p>

30	Equalization Voltage Point Setting	<p style="text-align: center;">EQV 30 29.2</p> <p>The default setting is 29.2V, with a configurable range of [25, 31.5V].</p>
31	Equalization Charging Time Setting	<p style="text-align: center;">EQE 31 60</p> <p>During the equalization stage, the controller will charge the battery as much as possible until the battery voltage rises to the battery equalization voltage. Then, it will adopt constant voltage regulation to maintain the battery voltage. The battery will remain in the equalization stage until the set battery equalization time is reached. The default setting is 60 minutes, with a configurable range of [5, 900], and an increment of 5 minutes for each setting.</p>
32	Equalization Delay Time Setting	<p style="text-align: center;">EQD 32 120</p> <p>During the equalization stage, if the battery equalization time expires and the battery voltage has not risen to the battery equalization voltage point, the charging controller will extend the battery equalization time until the battery voltage reaches the battery equalization voltage. When the battery equalization delay setting is completed and the battery voltage is still below the battery equalization voltage, the charging controller will stop equalization and return to the floating stage. The default setting is 120 minutes, with a configurable range of [5, 900], and an increment of 5 minutes for each setting.</p>

33	Equalization Interval Time Setting	E91 33 30d
		When the battery connection is detected during the float phase with the equalization mode turned on, the controller will start to enter the equalization phase when the set equalization interval (cell equalization period) is reached. The default setting is 30 days, the settable range is [1,90], and the increment of each setting is 1 day.
34	Enable Equalization Immediately	E97 34 OFF
		The default setting is OFF, the function is not turned on; when it is set to ON, in the float charging stage when the equalization mode is turned on and the battery connection is detected. The balance charging is activated immediately, and the controller will start to enter the equalization stage.
35	Grid tie inverter	G41 35 OFF
		Not Applicable for this model.
36	Battery dual output low voltage shutdown point	db4 36 292
		Not Applicable for this model.
37	Battery dual output duration	dbt 37 OFF
		Not Applicable for this model.
38	BMS Communication Function	bns 38 OFF
		Enable/Disable lithium battery communicates with inverter. Default setting is OFF. Choose the corresponding option based on the battery pack type. If a communication abnormality occurs, alarm 56 is generated.

39	Low SOC Shutdown	<p style="text-align: center;">b5U 39 OFF</p> <p>Set the inverter to shut down when the State of Charge (SOC) of the battery is low. Default setting is 20, with a configurable range of [5, 50]. When the lithium battery SOC reaches the set value in battery mode, the inverter shuts down and generates alarm 68. The alarm 68 is cleared when the SOC returns to the set value + 5%. In standby mode, the inverter can switch to battery mode only when the SOC reaches the set value + 10%. If it does not reach this threshold, alarm 69 is generated. Once the function is enabled, alarm 69 is triggered when the lithium battery SOC reaches the set value + 5%, and it is cleared when it returns to the set value + 10%. It can be set to OFF, in which case the inverter no longer performs shutdown, startup, or alarm operations based on the SOC condition. Once the function is enabled, if a communication abnormality occurs, the inverter no longer operates based on the SOC information and clears the related alarms.</p>
40	High SOC to Battery	<p style="text-align: center;">5t6 40 OFF</p> <p>Set the SOC value for the inverter to switch to battery mode. Default setting is 95, with a configurable range of [10, 100]. In PBG priority mode, when the lithium battery SOC reaches the set value in normal grid mode, the inverter switches to battery mode. Once enabled, the inverter will only switch to battery mode when the SOC is above the set point and the battery voltage is higher than the voltage point to switch back to battery mode It can be set to OFF, in which case the inverter no longer switches from grid mode to battery mode based on the SOC condition. Once the function is enabled, if a communication abnormality occurs, the inverter no longer operates based on the SOC information and clears the related alarms.</p>

41	Low SOC to Grid	STG 41 OFF
		<p>Set the SOC value for the inverter to switch to grid mode. The default setting is 50, with a configurable range of [10, 90]. In PBG priority mode, when the lithium battery SOC reaches the set value in battery mode, the inverter switches to grid mode. Once enabled, the inverter will switch to grid mode when the SOC is below the set point or the battery voltage is lower than the voltage point to switch back to grid mode</p> <p>It can be set to OFF, in which case the inverter no longer switches from battery mode to grid mode based on the SOC condition. Once the function is enabled, if a communication abnormality occurs, the inverter no longer operates based on the SOC information and clears the related alarms.</p> <p>When this setting is higher than the STB point, STB and STG will no longer take effect after the next activation.</p>

4.3 Display Information

The LCD display information will be switched in turns by pressing “UP” or “DOWN” key. The selectable information is switched as below order: voltage, frequency, current, power, firmware version.

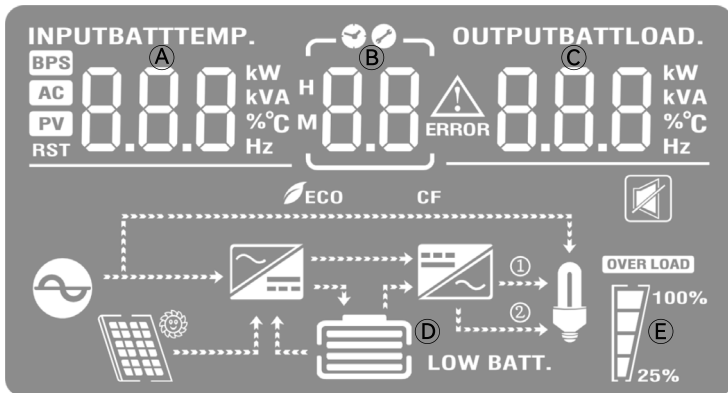

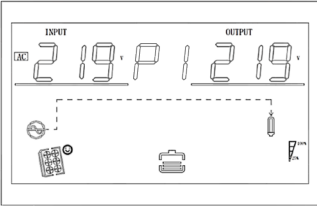
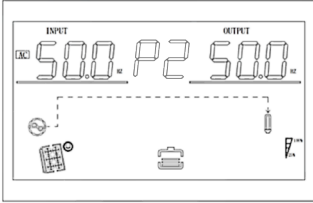
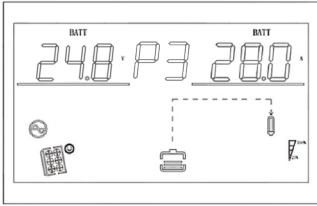
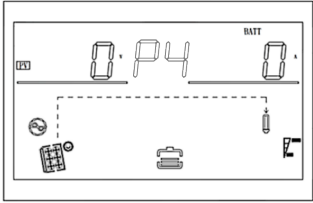
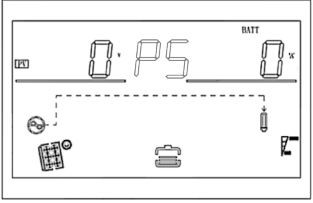
Information	LCD display
<ul style="list-style-type: none"> Ⓐ AC Input voltage Ⓑ Alarm or Fault code (Default Display Screen) Ⓒ Output voltage Ⓓ Battery capacity Ⓔ Load percentage 	
<ul style="list-style-type: none"> Ⓐ AC Input frequency Ⓑ Alarm or Fault code Ⓒ Output frequency Ⓓ Battery capacity Ⓔ Load percentage 	
<ul style="list-style-type: none"> Ⓐ Battery voltage Ⓑ Alarm or Fault code Ⓒ Output current Ⓓ Battery capacity Ⓔ Load percentage 	
<ul style="list-style-type: none"> Ⓐ PV voltage Ⓑ Alarm or Fault code Ⓒ PV charging current Ⓓ Battery capacity Ⓔ Load percentage 	
<ul style="list-style-type: none"> Ⓐ PV voltage Ⓑ Alarm or Fault code Ⓒ PV power Ⓓ Battery capacity Ⓔ Load percentage 	

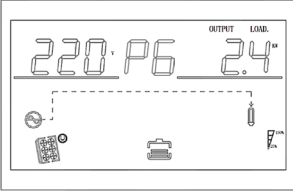
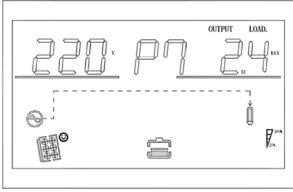
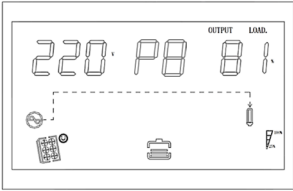
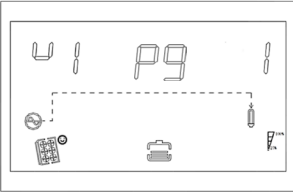
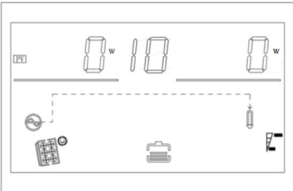
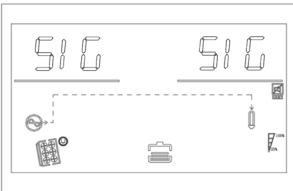
<ul style="list-style-type: none"> (A) Output voltage (B) Alarm or Fault code (C) active power output (D) Battery capacity (E) Load percentage 	
<ul style="list-style-type: none"> (A) Output voltage (B) Alarm or Fault code (C) complex power output (D) Battery capacity (E) Load percentage 	
<ul style="list-style-type: none"> (A) (B) Output voltage (C) Alarm or Fault code (D) load percentage (E) Battery capacity Load percentage 	
<p>Display software version</p>	
<p>Display photovoltaic power generation</p>	
<p>Parallel operation status</p>	

After enabling BMS, the following pages are available

Network status of lithium battery

When the upper right display shows SIG constant, the battery pack is operating as a single group; When it shows PAR constant, the battery pack is operating in multiple groups in series and parallel; When it flashes PAR, the battery pack is establishing a state of multiple groups in series and parallel

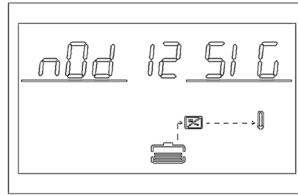

Lithium battery voltage and current information; The upper left displays BMS battery voltage information; The upper right displays BMS battery current information. When BMS communication fails, both the upper left and upper right displays will flash ERR

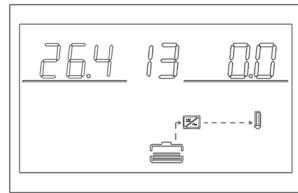

Lithium battery temperature and SOC; The upper left displays BMS temperature information; The upper right displays BMS SOC information. When BMS communication fails, both the upper left and upper right displays will flash ERR

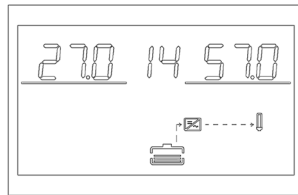

Lithium battery capacity; The upper left displays rated capacity; The upper right displays current capacity. When BMS communication fails, both the upper left and upper right displays will flash ERR

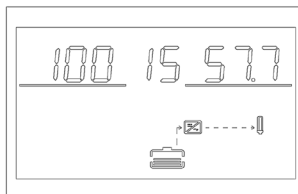

Lithium battery constant voltage point; The upper left displays the fixed letter CV; The upper right displays the BMS constant voltage charging point. When BMS communication fails, the upper right display will flash ERR

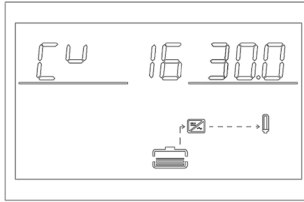

Lithium battery fault alarm information; The upper left displays BMS alarm information; The upper right displays BMS fault information. When BMS communication fails, both the upper left and upper right displays will flash ERR

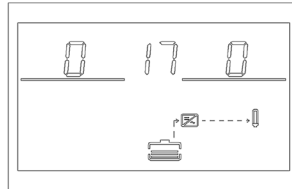

5. Fault Reference Code

Fault display:

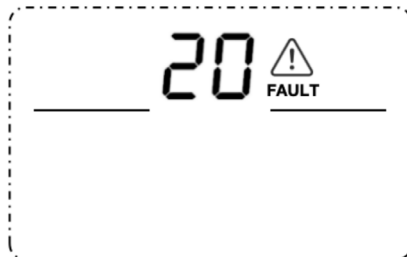

Function description: If alarm occurs, Fault indicator flashes and buzzer sounds every one second for 1 minute, then stop. If fault occurs, the fault indicator is always on, the buzzer sounds 10 seconds then stops. System will try restart automatically. If the machine does not work after six times' restart, the machine and LCD display will always in the fault status. You need to completely power off (off the screen) or wait for 30 minutes to restart the machine. The fault LCD display is shown in the figure above. In fault mode fault icon is bright, in alarm state alarm icon is flashing, and contact the manufacturer to troubleshoot the abnormal situation according to the fault information.

Fault: The inverter enters fault mode, with a constant red LED light and LCD displaying a fault code.

Fault code sheet

Fault code	Meaning	Relevant action	Trigger conditions	Resume conditions	Fault / Alarm
1	Bus soft boost start failed	Turn fault mode	Bus voltage does not reach set value for more than 30 seconds.	Cannot restore.	Fault
2	Bus voltage high	Turn fault mode	The bus voltage is higher than protection point.	Cannot restore.	Fault
3	Bus voltage low	Turn fault mode	Bus voltage is below the under voltage protection point.	Cannot restore.	Fault
4	Battery over current	Turn fault mode	TZ interrupt triggered more than 2 times within 2ms.	Cannot restore.	Fault
5	Over temperature	Turn fault mode	The PFC temperature exceeds the protection threshold. Fan stuck for more than 5 minutes.	Tried to restart six times, if failed, cannot restore.	Fault
6	Battery high voltage	Turn fault mode	Battery voltage is higher than set value.	Restore after voltage is lower set value.	Fault
7	Bus soft start fault	Turn fault mode	Turn fault mode. The soft start process has exceeded but the bus voltage has not reached set value.	Cannot restore.	Fault

Fault code	Meaning	Relevant action	Trigger conditions	Resume conditions	Fault / Alarm
8	Bus short circuit	Turn fault mode	Inverter on or PFC on, bus voltage below threshold.	Cannot restore.	Fault
9	Inverter soft start fault	Turn fault mode	The bus voltage is higher than protection point, or the DC component is greater than 20V. or the inverter is not completed within 5 minutes.	Cannot restore.	Fault
10	INV over voltage	Turn fault mode	The inverter voltage is higher than the set value [276V].	Cannot restore.	Fault
11	INV under voltage	Turn fault mode	Battery mode and there is no short circuit in the inverter, the inverter voltage is lower than 160V.	Cannot restore.	Fault
12	INV short circuit	Turn fault mode	In battery mode or Standby mode, if the inverter voltage is lower, current is greater than set value.	Tried to restart six times, if failed, cannot restore.	Fault
13	Negative power protection	Turn fault mode	In battery mode, the load power is lower than set value(negative power, such as -1200W).	Cannot restore.	Fault
14	Over load	Turn fault mode	Overload exceeds limit (list in specification).	Tried to restart six times, if failed, cannot restore.	Fault
15	Model fault	Turn fault mode	Cannot match any model in model number detection.	Cannot restore. Check whether the control board is assembled incorrectly or whether the program is burned incorrectly.	Fault

Fault code	Meaning	Relevant action	Trigger conditions	Resume conditions	Fault / Alarm
16	No boot loader	Turn fault mode	No boot loader.	Cannot restore. Try to send command TIDA1911000000000000.	Fault
26	BMS fault	Turn fault mode	Error code in BMS message.	Turn off BMS communication function or BMS fault recovery.	Fault
28	NTC fault	Turn fault mode	NTC open circuit	Cannot restore	Fault
29	Inverter over current	Turn fault mode	Instantaneous current of inverter is higher than set value.	Tried to restart six times, if failed, cannot restore.	Fault

6. Alarm Reference Code

Alarm: the inverter does not enter the fault mode, LED red light flashing, LCD displays the Alarm code.

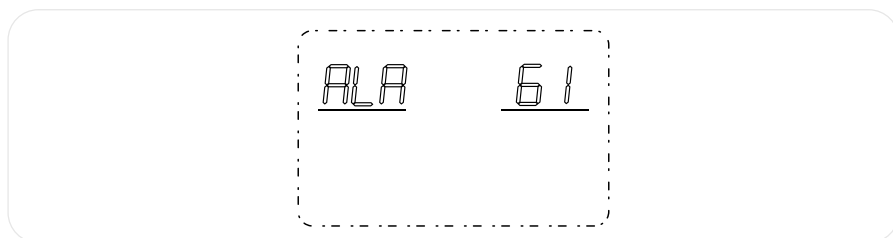

Alarm code sheet

Alarm code	Meaning	Relevant action	Trigger conditions	Resume conditions	Fault / Alarm
50	Battery open	Alarm, battery does not charge.	Battery voltage is below set point.	Restore after battery voltage recover.	Alarm
51	Battery low voltage shutdown	Alarm, battery low voltage shutdown or cannot power on.	Battery voltage is below set point.	Restore after battery voltage recover.	Alarm

Alarm code	Meaning	Relevant action	Trigger conditions	Resume conditions	Fault / Alarm
52	Battery low voltage	Alarm	Battery voltage is below set point.	Restore after battery voltage recover.	Alarm
53	Charger short circuit	Warning, battery does not charge.	The battery voltage is less than 5V and the charging current is greater than 4A.	Cannot restore.	Alarm
54	Low power discharge	Alarm	The battery voltage is greater than 26.4V and the discharge time exceeds the set low-power discharge time.	Restore after battery voltage recover.	Alarm
55	Battery over charge	Alarm, battery does not charge.	Battery voltage is higher than the set value.	Can restore.	Alarm
56	BMS disconnect	Alarm, lock standby mode.	No correct BMS communication response within 10 seconds.	Restore after communication recover.	Alarm
57	Over temperature	Alarm, battery does not charge.	The temperature of PFC or INV is above the set value.	Restore after temperature is under set value.	Alarm
58	Fan error	Alarm, if one fan fails and the other fan is running at full speed.	Fan speed is less than the set value.	Restore after fan recover.	Alarm

Alarm code	Meaning	Relevant action	Trigger conditions	Resume conditions	Fault / Alarm
59	EEPROM error	Alarm	Numerical calibration error.	Restore after calibration right.	Alarm
60	Overload	Alarm, battery does not charge.	When not in mains mode or the PV is normal and the output priority is not mains priority, the load exceeds 102% and the duration is 200-220 ms.	Restore after load back to normal	Alarm
61	Abnormal generator waveform	Alarm, continuously operating in battery mode.	Generator waveform detection result is abnormal.	Can restore.	Alarm
62	PV Energy Weak	Alarm, turn off PV output and charging.	When the battery is not connected, the bus voltage is lower than the set value.	Restore after 10mins.	Alarm
63	Synchronization signal fail	Alarm, turn fault mode.	Host or slave with host present, no synchronization signal restored within set value	Restore after signal recover.	Alarm
68	SOC Under	Alarm, turn standby mode.	Lithium battery SOC is lower than the set value.	Restore after turning off the low SOC shutdown function, or turning off the BMS communication function, or when the SOC returns to the set value + 5%.	Alarm

Alarm code	Meaning	Relevant action	Trigger conditions	Resume conditions	Fault / Alarm
69	SOC Low	Alarm, if it is in standby mode, it will remain in standby mode and not power on.	Lithium battery SOC is lower than the set value + 5% (mains mode or battery mode), lower than the set value + 10% (standby mode).	Restore after turning off the low SOC shutdown function, or turning off the BMS communication function, or when the SOC returns to the set value + 10%.	Alarm
70	Battery terminal source fail	Alarm, turn standby mode	Battery is not connected and the voltage of battery terminal is lower than set value.	Restore after battery is detected or detected that the battery terminal voltage exceeds the set value for one consecutive minute.	Alarm

7. Battery Equalization

Equalization function is added into charge controller. It reverses the buildup of negative chemical effects like stratification, a condition where acid concentration is greater at the bottom of the battery than at the top. Equalization also helps to remove sulfate crystals that might have built up on the plates. If left unchecked, this condition, called sulfation, will reduce the overall capacity of the battery. Therefore, it's recommended to equalize battery periodically.

Note:*Don't activate this mode when using lithium batteries.

- How to Apply Equalization Function

You must enable battery equalization function in monitoring LCD setting Program 29 first.

Then, you may apply this function in device by either one of following methods:

- 1.Set balance mode on Program 29.
- 2.Set balance voltage point on Program 30.
- 3.Set balance charging time on Program 31.
- 4.Set balance delay time on Program 32.
- 5.Set balance interval time on Program 33.
- 6.Set immediate balance mode activation on Program 34.

- When to Equalize

In float stage, when the setting equalization interval (battery equalization cycle) is arrived, or equalization is active immediately, the controller will start to enter Equalize stage.

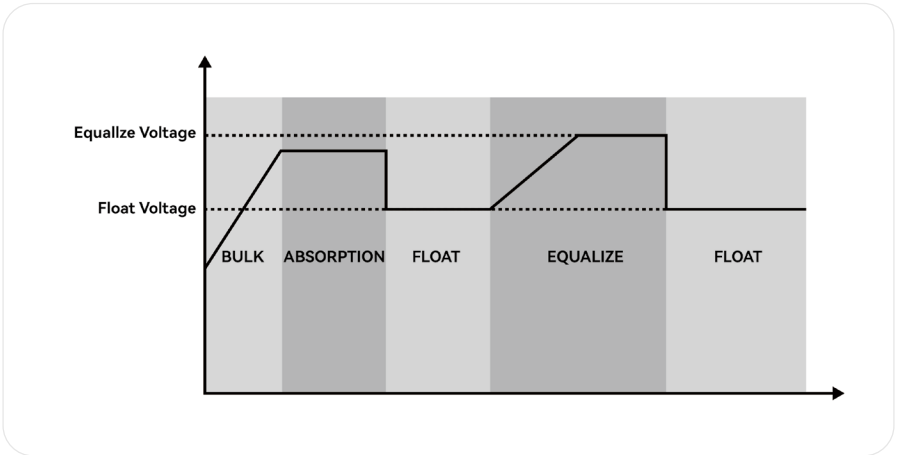

- Equalize charging time and timeout

In Equalize stage, the controller will supply power to charge battery as much as possible until battery voltage raises to battery equalization voltage. Then, constant-voltage regulation is applied to maintain battery voltage at the battery equalization voltage. The battery will remain in the Equalize stage until setting battery equalized time is arrived.

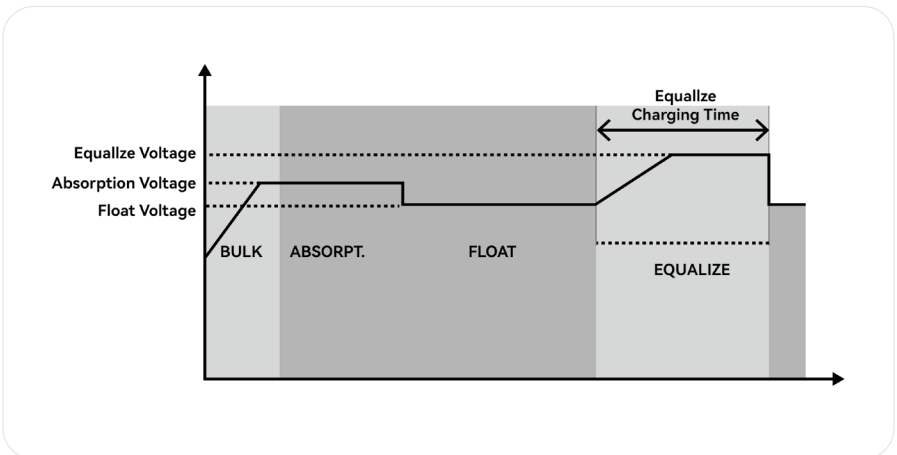

However, in Equalize stage, when battery equalized time is expired and battery voltage doesn't rise to battery equalization voltage point, the charge controller will extend the battery equalized time until battery voltage achieves battery equalization voltage. If battery voltage is still lower than battery equalization voltage when battery equalized timeout setting is over, the charge controller will stop equalization and return to float stage.

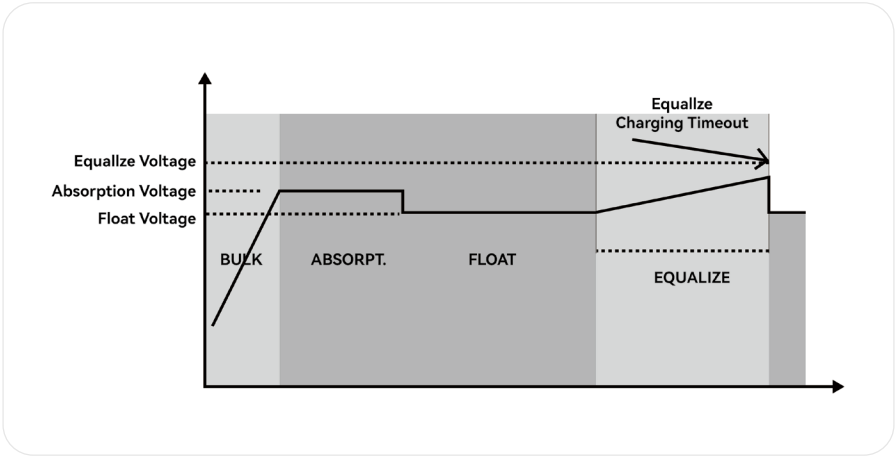

8. Specifications

8.1 Line Specifications

	Item	Value	Comments
Input voltage	Main topology	L + N + PE	
	Nominal voltage	220Vac	Settable: 208/220/230/240 Vac
	Input voltage range	90~280Vac	Settable
	Input low loss		154Vac (default) Settable: 90-154
		185Vac (default) Settable: 170-200	UPS mode

	Item	Value	Comments
Input voltage	Input low comeback	Low loss voltage +9V	
	Input high loss	264Vac(default) Settable:264-280	Appliance mode Generator mode
		264Vac	UPS mode
	Input high comeback	High loss voltage -9V	
	Nominal frequency	50 / 60Hz	
	Frequency range	40 / 70Hz	
	Freq. low loss / Comeback	40/43.5Hz@50Hz(UPS mode) 40/40.5HZ@50HZ(APP/GEN mode)	
		50/53.5Hz@60Hz(UPS mode) 50/50.5HZ@60HZ(APP/GEN mode)	
	Freq. High loss / Comeback	60/56.5Hz@50Hz(UPS mode) 70/69.5Hz@50Hz(APP/GEN mode)	
		70/66.5Hz@60Hz(UPS mode) 70/69.5Hz@60Hz(APP/GEN mode)	
	Max current (RMS)	20A	>20A,60s; >22A,10s; >24A,3s; >26A,200ms;

Note: When the specification of the external circuit breaker is greater than 20A, the maximum input current is 20A.

When the external circuit breaker specification is less than 20A, the maximum input current depends on the external circuit breaker specification.

8.2 Battery Specifications

* N= battery pieces

	Item	Value	Comments
Battery information	Battery pieces	2pcs	12V/PCS
	Auto restart function	Yes	
	Battery test function	No	
	Battery type	VRLA/LI	
	Nominal battery voltage	N*12V	@25°C
	Battery management	Yes	
Battery protection	Battery over voltage	30.5V	
	Battery under voltage	10.5V*N	Settable:10*N~11*N
	Battery low voltage alarm	10.8V*N	Settable:10.3*N~11.3*N
	Over current protection	Fuse	Fast acting

8.3 Charger Specifications

	Item	Value	Comments
Charger(line mode)	Charging voltage	FV MODE: 27V Settable: 26.6~27.8V CV MODE: 28.2V Settable: 28~29V	
	Temperature compensation	No	
	Charging current	2~100A	Settable
	Default charging current	40A	
	Charging mode	Two/Three/Auto Settable	Three states: CC/CV/Float Two states: CC/Float
	Charge voltage accuracy	±5%	Calibrated by RS232
Charger(PV)	PV charging method	MPPT	
	PV maximum input power	5000W	
	PV maximum input current	18A	
	Efficiency	99.5%max	
	PV voltage accuracy	±2%	
	MPPT voltage	40~450Vdc	
	Default charging current	60A	
	Recommended PV configuration voltage	MPPT Voltage: 300-340V Open Circuit Voltage: 370-430V	
	Max PV voltage	500Vdc	
	Min PV voltage	40Vdc	
PV start-up voltage	60Vdc	If PV voltage is below 60V, inverter needs to be connected to the battery for use. While PV voltage is above 60V, inverter can work without battery.	
Max PV charge current	100A		

8.4 Output Specifications

	Item	Value	Comments
Output power rating	Output topology	L+N+PE	
	Output power	3.6KW	When setting the Output voltage to 208V, the Output Power rating will be reduced to 90%; Please refer to the Battery Voltage Derating Curve ① and Max Output Power rating② for more details.
Output voltage	Nominal voltage	208/220/230/240 VAC	Default 220V, manual set by RS232 or LCD
	Waveform	Sinusoidal	
	Voltage regulation	±5%	
	DC offset	±200mV (Bat mode)	Empty load and linear load mode
Output frequency	Nominal frequency	50 / 60Hz	50/60Hz auto selection (default on) manual set by RS232, default 50 Hz
	Line mode	50Hz: (43.5 - 56.5)Hz (UPS mode) (40 - 70)Hz (APP/GEN mode) 60Hz: (53.5 - 66.5)Hz (UPS mode) (40 - 70)Hz (APP/GEN mode)	
	Battery mode	50 / 60Hz	
	Frequency regulation	±0.1Hz	
Output overload battery mode	102%<Load ≤110%	1 minute minimum, then alarm and turn off output	
	110%< Load ≤130%	10 seconds minimum, then alarm and turn off output	
	130%<Load ≤150%	3 seconds minimum, then alarm and turn off output	
	Load>150%	200 ms minimum, then alarm and turn off output	
Output short circuit protection	Battery mode	Current limitation	
	Line mode	Breaker (20A)	

① Battery Voltage Derating Curve

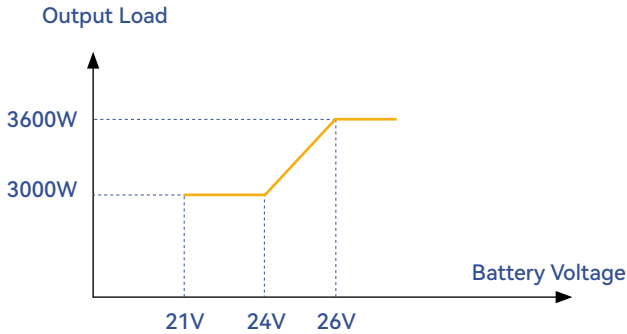

② Max Output Power rating

Max Output Power rating			
Battery	PV	AC Input	Max Output Power
L	N	N	Follow the battery voltage derating curve as shown in ①.
N	L	N	Depends on the PV input power and Maximum is 3.6kW.
N	N	L	Input Voltage * Input Max current 20A
L	L	N	Two ways to achieve 3.6kW are as follows: 1. Battery Voltage ≥ 26V; 2. Battery Voltage ≥ 21V and PV Input Power ≥ 900W; If none of the above conditions are met, then follow the battery voltage derating curve as shown in ①.
N	L	L	Input Voltage * Input Max current 20A
L	N	L	Input Voltage * Input Max current 20A
L	L	L	Input Voltage * Input Max current 20A

Note: The "L" in the diagram represents the meaning of being accessed or connected, while the "N" signifies the meaning of not being accessed or not being connected.

8.5 Switch Time Specifications

	Items	Value	Comments
Switch time	Line Mode To Battery Mode	10ms(typical)	UPS mode
		10ms(typical)	Appliance mode
		20ms(typical)	Generator mode

8.6 Efficiency Specifications

	Item	Value	Comments
Efficiency	Line Mode	>99.5%@3KVA >99.5%@5KVA	Full R load, without battery connect.
	Battery Mode	>92%@1KVA >92%@2KVA >90%@3KVA	Full R load.
	Standby power	<65W	Empty load mode, battery disconnected.

9. Trouble Shooting

Problem	Fault Event	Trigger conditions	What to do
LED screen display fault code 5	Overtemperature	1.PFC temperature exceeds the protection threshold [85°C when not locked rotor, 65°C when locked rotor] for more than 20 seconds. 2.Fan lock exceeds 30 seconds.	Please check if the fan is not connected or if there are loose wiring issues. If the fan is not connected for more than 30 seconds, the machine will report fault code 5.
LED screen display fault code 12	Inverter short circuit	In battery mode or standby mode, if the inverter voltage is lower than 100V and the inverter current is greater than 40A, it should respond within 80-100ms.	1.Check if there is a short circuit at the output terminals (such as a screw piercing through the locking terminal causing a LN short circuit). 2.Verify if the inverter voltage and inverter current meet the triggering conditions.
LED screen display fault code 15	Model malfunction	The model number detection does not match any model number.	Check if the control board is assembled incorrectly or if the program is burned incorrectly.
LED screen display fault code 16	No boot program	The third digit of the communication is not 1.	Send command: TIDA1911000000000000

Problem	Fault Event	Trigger conditions	What to do
LED screen display fault code 20	CAN communication error	In battery mode, if the battery mode is set to mains power mode and the parallel mode is set to mains power mode, the number of responses from the slave devices does not match the previously defined number of slave devices. Receiving communication from two or more devices with a slave number of 0 consecutively.	1.Check if the parallel mode is set but the machine is turned on in single machine mode. 2.Check if the parallel connection cable and the parallel board are connected according to the parallel SOP (Standard Operating Procedure).
LED screen display fault code 58	Fan malfunction	Any of the fans rotating less than 8 times within 2 seconds.	1.Check if the fan is not connected properly or if there are any loose connections. 2.If the fan is properly connected: a) Check if there is any issue with the fan detection circuit, usually caused by excessive soldering underneath the control board socket. b) Check if the fan itself is damaged.
Unable to start	Battery	Due to the need for a voltage of $\geq 11.5V/N$ to start the machine in battery mode, common reasons for failure to start include improper calibration or insufficient battery voltage.	1.Check if the battery voltage sampling is functioning properly and if the battery voltage has been calibrated. 2.Use a multimeter to measure the voltage at the battery terminals (using a DC power supply or a real battery) to see if it reaches the minimum voltage of 11.5V per cell for startup. Note: It is crucial to configure the battery voltage according to the machine model. Connecting the wrong battery voltage can cause capacitor explosion.

Problem	Fault Event	Trigger conditions	What to do
	Utility power		<p>1.Check for any short circuits at the mains terminal (such as a screw piercing through and causing a short circuit between the live and neutral terminals).</p> <p>2.Check if there are any wiring errors, such as mistakenly connecting the mains input to the output terminals.</p>
	PV		<p>1.Check if the PV input voltage is too close to the critical threshold.</p> <p>2.For low voltage versions of the machine, check if the software version numbers of the main control is compatible. If the software versions differ significantly, the machine may not be activated.</p>
PV not charging			<p>1.For low voltage versions of the machine, check if the software version numbers of the main control is compatible. If the software versions differ significantly, the machine may not be activated.</p> <p>2.Connecting the wrong battery voltage can result in damage to the auxiliary power supply on the PV side, causing a loss of power and inability to communicate with the main control.</p>

